

# DEMYSTIFYING THE EFFECTS OF LOUDSPEAKER CABLES

L-ACOUSTICS

## 1 INTRODUCTION

Today's professional sound installations such as sport facilities, theme parks and entertainment venues require sound quality, high sound pressure level and improved frequency bandwidth, which results in the specification of low impedance systems instead of public address systems based on 100 V / 70 V line speakers. As cable lengths may sometimes go beyond a hundred meters, it can result in high power loss when driving a full spectrum amplified signal. This paper presents a complex impedance model of speaker cables that includes two electromagnetic phenomena: inductive effect and skin effect. The following parameters have been investigated: cable length up to two hundred meters and cable gauge from 4mm<sup>2</sup> to 10mm<sup>2</sup> in relation with various speakers each with different impedance loads. Then follows an in-depth interpretation of the cable impact on audio signal when connecting an amplifier and a loudspeaker voice coil. Along with all simulations of power loss is presented an acoustic measurement highlighting the accuracy of the model. This powerful tool may be an asset for sound designers and integrators to predict the impact of long cable runs on loudspeakers output.

## 2 HISTORICAL PERSPECTIVE

### 2.1 The Damping Factor

The Amplifier Damping Factor is widely interpreted as describing the amplifier's ability to control undesirable movement of the speaker cone near resonant frequency. It is still a common belief that a high Amp DF has a significant effect on low-frequency drivers, giving a tighter transient in the bass region. Introduced at the beginnings of high-fidelity audio, this value was originally calculated as follows:

$$Amp\ DF = \frac{Z_{load}}{Z_{out}} \quad (1.1)$$

$Z_{load}$  = loudspeaker impedance,  
 $Z_{out}$  = amplifier output impedance.

A voice coil in motion creates a back electromotive force. At the frequency where mechanical resonance tends to drive this motion, a high DF would allow the amplifier to keep control over the speaker system, because the low source impedance seen by the loudspeaker acts as a brake. However, some audio scientists very soon argued that DF was failing to assess the real coupling of an amplifier and a speaker as a resonant system.

In "The Damping Factor Debate" (1967), Augsperger explains that the electrical resistance of the voice coil itself should be included in the load perceived by the isolated speaker, and examines what he calls the Overall DF, calculated as follows:

$$Overall\ DF = \frac{Z_{load}}{Z_{out} + Z_{load}} \quad (1.2)$$

Looking at the table reproduced in Figure 1, the conclusion is obvious: trying to enhance the Amp DF over 20 does not lead to any significant increase of the actual Overall DF. Other articles, such as Floyd E. Toole in "Damping, Damping Factor and Damn Nonsense" (1975) and Richard Clarke "Damping Factor" (2000), point to the same conclusion in alternative ways.

From there, a shift occurred somehow, probably because the audio community was looking for a simple rule of thumb: “not necessary to go over 20” became “must be at least 20,” even though no conclusion had been made for values below 20.

Amplifier R, (ohms)	Amplifier DF	Actual Over-All DF
8	1	0.57
4	2	0.80
2	4	1.0
1	8	1.14
0.5	16	1.23
0.25	32	1.28
0.125	64	1.30
0.05	160	1.32
0.025	320	1.33
0.0125	640	1.33
0.0000	Infinity	1.33

Table 1. The actual damping factor (with loudspeaker connected) is limited by the speaker voice-coil resistance. Figures are for 8-ohm output terminals to which speaker having nominal 8-ohm impedance and 6-ohm voice-coil resistance is connected.

Figure 1 : Damping factor according to Augsperger

It should be noted that the influence of the connecting cable is never considered in the above formulations. In fact, given the high impedance values of amplifiers at the time of DF introduction, the short cable length used in hi-fi audio chain added negligible resistance to the circuit. However, taking into account modern professional sound reinforcement, speaker cable length becomes a crucial factor in calculating Damping Factor.

With the exception of self-powered speakers, professional sound system installations usually involve long cables. Cable resistance must be taken into account in the output impedance seen by the loudspeaker. Moreover, amplifiers now achieve very low output impedance (e.g. L-Acoustics’ LA8: 0.01 Ω), to the point that this parameter has become insignificant compared to cable resistance. Following these observations, some pro-audio recommendations for maximum cable length try to limit cable resistance with the infamous “DF>20” criterion, using the following formula:

$$DF = \frac{Z_{load}}{Z_{out} + Z_{cable}} \tag{1.3}$$

But again, if many have witnessed differences upon listening, especially in the bass region and at very low DF, no scientific evidence shows that the best speaker performance is obtained for DF>20. As early as 1954, Tomcik argued that there is a Critical Damping Factor which depends on each loudspeaker design and at which speaker performance is at its maximum. Above or below this value, a speaker system is respectively under-damped or over-damped. The same idea can be found in the famous Thiele/Small parameters. Our statement is that basing cable length recommendations on DF>20 is inaccurate. This not to say that there is no effect of source impedance on bass transient but, in the absence of more detailed work on the subject, there is a more relevant matter to focus on.

## 2.2 Power loss in cable

The important issue at stake is power loss in cable. This factor is often overlooked, but has a tremendous impact on professional sound installations, where the priority is to match specifications in terms of bandwidth and sound pressure level, to a point where the damping factor debate is of secondary importance.

The issue of power loss induced by long cables was raised long ago, but its effect was rapidly assumed to come solely from the resistive nature of wires. The basic formula describing the resistance of a cable is:

$$R_{Cable} = 2 \frac{\rho l}{S} \tag{2.1}$$

$\rho$  = resistivity of the conductor  
 $l$  = cable length  
 $S$  = section of the conductor

As signal is carried by a pair of connector, cable resistance must be counted twice, which explains the factor of two in the formula.

The problem could first be tackled by increasing the cable section  $S$  to minimize resistive loss. But when it comes to sound systems addressing large venues, this could lead to non-negligible cost in copper.

The real solution appeared with the deployment of 70V / 100V lines, using exactly the same principle as high power lines to carry electricity over long distances. The amplifier equipped with a step up transformer to the speaker equipped with a step down transformer, allows sound to be carried over enormous distances using thin wires at high voltage and high impedance, while avoiding most of the resistive loss. Therefore, large venues such as stadiums, airports and resorts were massively equipped with 70V / 100V line speaker systems.

Today, with the growing demand in sound pressure level, sound quality and frequency bandwidth, high end loudspeaker manufacturers tend to develop low impedance speakers, which inevitably lead to high power loss when driving high power and full spectrum signals through long distances.

While the need to understand the impact of cables on speaker responses grows in the industry, L-Acoustics has established a reliable model to truly explain and predict these power losses. This model is illustrated in the next section.

### 3 CABLE MODEL

#### 3.1 Transmission line model, assumptions

Speaker cables are composed of a certain number of twisted pairs of connectors, usually made of copper. The following figure shows the section of a very commonly used speaker cable format, the 2-way speaker cable. Four wires (1+, 1-, 2+ and 2-) drive two signals.



Figure 2 : typical 2-way speaker cable cross-section

In this study, we consider one pair of wires as a basic transmission line, based on the “RLGC” model. The amplifier is considered as an alternative voltage generator  $U(t)$  and a series resistor  $R_{out}$  which corresponds to its nominal output impedance.

The electrical circuit that connects amplifier and speaker is illustrated in the following diagram:

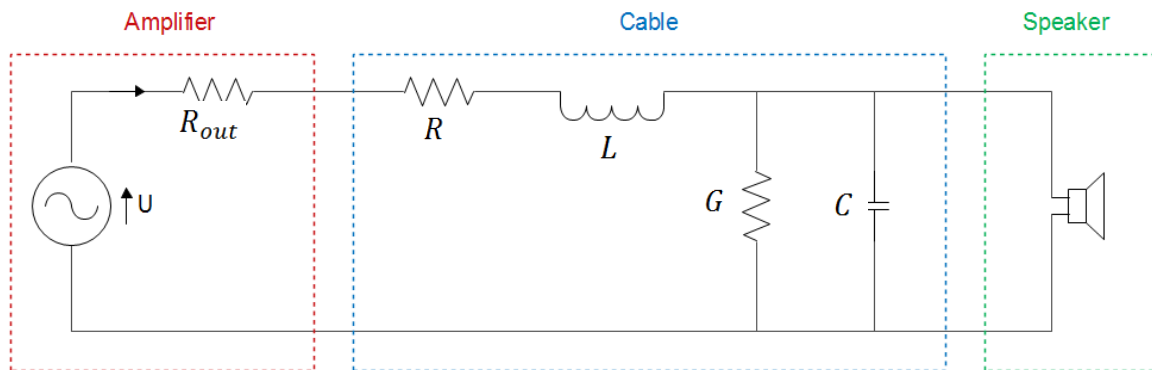

Figure 3: Electrical circuit based on the “RLGC” model

Since we are only concerned by audible spectrum, our first assumption here will be to take the parallel components  $G$  and  $C$  out of the equation, as they only matter at very high frequencies (RF) and can be neglected as high as 20 kHz. The diagram becomes:

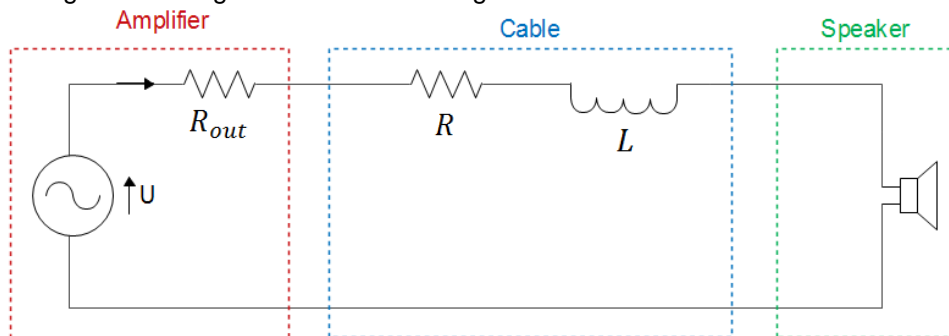

Figure 4: Electrical circuit,  $G$  and  $C$  being neglected

Another parameter that is often neglected in the Hi-Fi world is the inductance  $L$ . It is a crucial factor in pro-audio that must be considered when dealing with long cable runs.

The last general assumption which needs to be avoided is to calculate  $R$  as a constant resistance without taking into account the skin effect occurring at high frequency. The two next parts will focus on these often overlooked electromagnetic effects: inductive reactance and skin effect.

### 3.2 Inductive reactance

Whenever a current travels through a conductor, it produces a magnetic field. An AC current will then generate a time-varying magnetic field in the form of concentric cylinders around the wire. Whenever this magnetic field travels through a neighbor conductor, by the same principle, it induces a current flow in the opposite direction of the original current. This is called inductive reactance.

As a consequence, a pair of conductors behaves as an inductor which corresponds to  $L$  in the previous diagram and this inductive effect is proportional to the frequency.

In the complex plan, the impedance of that component is known as:

$$Z_L = 2jL_0l\omega \tag{3}$$

$l$  = Cable length (m)

$L_0$  = Linear self-inductance of the wire (H.m-1)

$\omega = 2\pi f =$  Pulse (rad.s-1)

The linear self-inductance  $L_0$  can vary from one cable manufacturer to another. This parameter depends on the connector diameter, the number of connectors and the distance between them. Wires are usually twisted together, reducing the inductive effects significantly. In this model, we use the typical values given by cable manufacturers. These values were then confirmed by RLC meter measurements.

Inductive reactance happens to be the major cause of power loss in the high frequencies. As linear inductance decreases when cable gauge increases, thinner cables will generate slightly more inductive reactance.

### 3.3 Skin effect

Skin effect is a tendency for alternating current (AC) to flow mostly near the outer surface of an electrical conductor, increasing the wire effective resistance. This effect becomes more apparent as the frequency increases. An alternating current flowing through a conductor generates an alternating magnetic field around it, these changes in magnetic field induce an electric field which opposes the changes of current intensity. This electric field is called counter electromotive force, it is greater at the center of the conductor and forces the electrons to flow near the outer surface.

The skin depth is defined as the distance below the surface of the conductor which is effectively used by current. It can be calculated as follows:

$$\delta = \sqrt{\frac{\rho}{\pi\mu f}} \tag{4}$$

$\rho$  = resistivity of the conductor

$\mu = \mu_r\mu_0$

$\mu_0$  = vacuum permeability

$\mu_r$  = relative magnetic permeability of the conductor

At low frequencies, skin effect is absent as the whole conductor is used by current, but as we increase frequency, it kicks in whenever the skin depth becomes lower than the conductor radius. As a practical example, using a 4mm<sup>2</sup> speaker cable which corresponds to a radius of 1.12mm, skin effect appears at 3.3 kHz and gets more drastic as frequency increases. Using a 6mm<sup>2</sup> cable - radius of 1.38mm, skin effect appears at 2.2 kHz, and will be more important at a given frequency when compared to a thinner cable, as illustrated in figure 5.

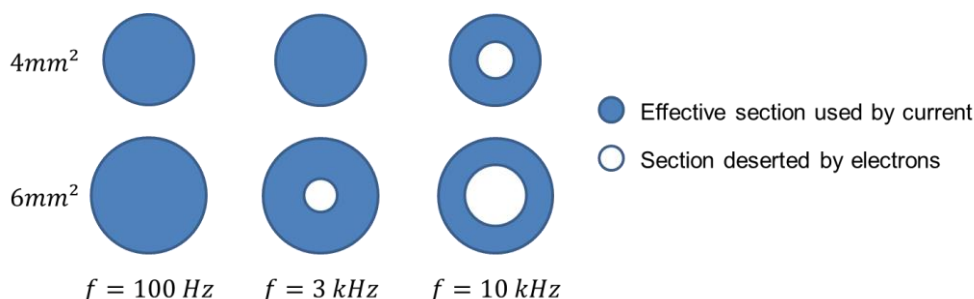

Figure 5: Three stages of skin effect in 4mm<sup>2</sup> and 6mm<sup>2</sup> section cables

This is the first important fact to comprehend about cabling: enhancing cable section does reduce resistive loss, but not as much as we could expect, because skin is also increased in the process.

The resistive part of the cable (2.1) is now given by:

$$R(f, S) = 2 \frac{\rho l}{S(r, f)} \tag{2.2}$$

$$\text{with } S = \pi r^2 \text{ if } f < \frac{1}{\pi \rho \mu r^2}$$

$$S = \frac{1}{\rho \mu f} \text{ otherwise}$$

## 4 SIMULATION

### 4.1 Influence of speaker impedance

Simulating the actual power loss induced by speaker cables, we need to focus on the last unknown of the equation, the speaker itself.

Speaker manufacturers provide a specification called nominal impedance, usually 4Ω or 8Ω, sometimes 16Ω. This value is widely interpreted as a resistive constant and only characteristic that defines a speaker, which is in fact, far from being true.

The impedance  $Z_{load}$  of a speaker has a resistive part  $x$ , as well as an inductive part  $y$ . Also, this complex number can be defined by its module  $R$  and its phase  $\theta$  as follows:

$$Z_{load} = x + jy = Re^{i\theta} \tag{5}$$

Nominal impedance only refers to the approximate designed value of a loudspeaker. The actual impedance varies considerably with changes in frequency. Figure 6 shows module and phase of speaker B, which has nominal impedance of 8Ω.

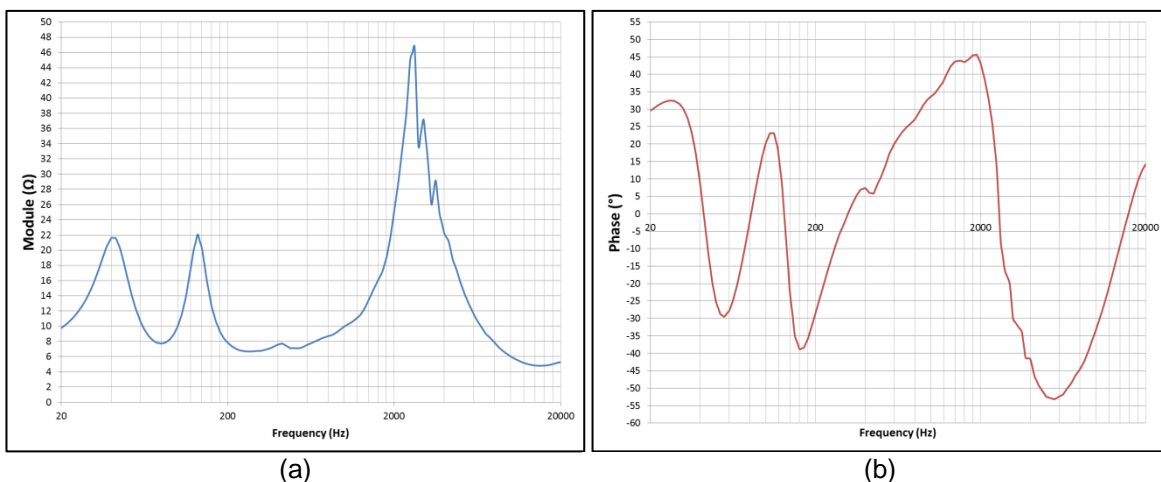

Figure 6: Impedance of speaker B. (a): Module, (b): Phase

It is important to avoid this misconception about impedance, as module and phase play a key role on how cables alter the overall frequency response of a speaker. It is also important to note that we are addressing the electrical phase of a speaker here, not acoustic phase which is a totally different matter.

As we try to comprehend the power loss induced by a cable, we need to consider not only the cable itself, but the overall electrical chain. In fact, the result we are trying to achieve is not just about

cable loss, it is about evaluating the coupling between all these elements as complex numbers, from amplifier output to loudspeaker voice coil.

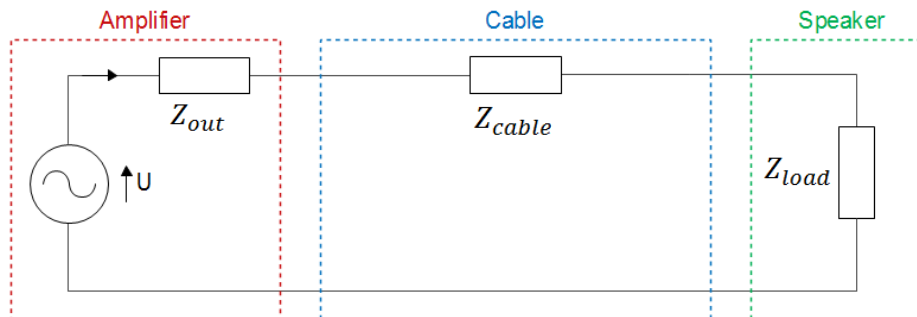

Figure 7: Complex electrical circuit

$U(t)$  = output signal sent by amplifier

$Z_{out} = R_{out}$  = amplifier output impedance

$$Z_{load} = \frac{R e^{i\theta}}{n}$$

$n$  = number of speakers in parallel

$$Z_{cable} = Z_R + Z_L = 2 \frac{\rho l}{S(r, f)} + 2jL_0 l \omega$$

## 4.2 Equation of cable loss

What we want to evaluate now is transfer function between the signal fed to the loudspeaker  $U_s(t)$  and the signal sent by the amplifier  $U(t)$ . A voltage divider between  $U_s(t)$  and  $U(t)$  gives:

$$\frac{U_s(t)}{U(t)} = \frac{Z_{load}}{Z_{out} + Z_{cable} + Z_{load}} \tag{6.1}$$

We can calculate the relative gain between output signal at amplifier and input signal at speaker:

$$G_{dB} = 20 \log \left| \frac{Z_{load}}{Z_{out} + Z_{cable} + Z_{load}} \right| \tag{6.2}$$

$$G_{dB} = 20 \log \frac{\frac{R}{n}}{\sqrt{\left(\frac{R}{n} \cos \theta + 2 \frac{\rho l}{S(r, f)}\right)^2 + \left(\frac{R}{n} \sin \theta + 4lL_0\pi f\right)^2}} \tag{6.3}$$

We have modeled an equation that predicts the direct influence of a cable on the frequency response of a particular speaker. It does not give absolute SPL but relative value between, for instance, a speaker connected with a 50m cable and the same speaker connected with a hypothetical “0m” cable.

### 4.3 Acoustics measurements versus simulation

In order to validate this model, L-Acoustics has undertaken a large series of measurements. The following parameters were investigated: cable length (0m – 50m – 100m – 150m), cable gauge (4x4mm<sup>2</sup>, 4x6mm<sup>2</sup>, 4x10mm<sup>2</sup>), various loudspeaker models (full-range – subwoofers, passive – active) and different number of enclosures in parallel on the same output channel (1 - 2 - 3 - 4 - 5 - 6).

All measurements were done with the same temperature and humidity conditions, same amplifier (L-Acoustics LA8) and with a microphone set at 10 meters on the ground. Measured values were at least 18 dB above background noise. Finally all plots were referenced to the “0m” value.

The following figures show comparisons head-to-head between plots simulated according to the previous formula (6.3) and the acoustic measurements, over 100 Hz to 20 kHz. Two 2-way passive speaker models, A and B, are shown here to emphasize how different the results can be from one loudspeaker to another.

- Varying length

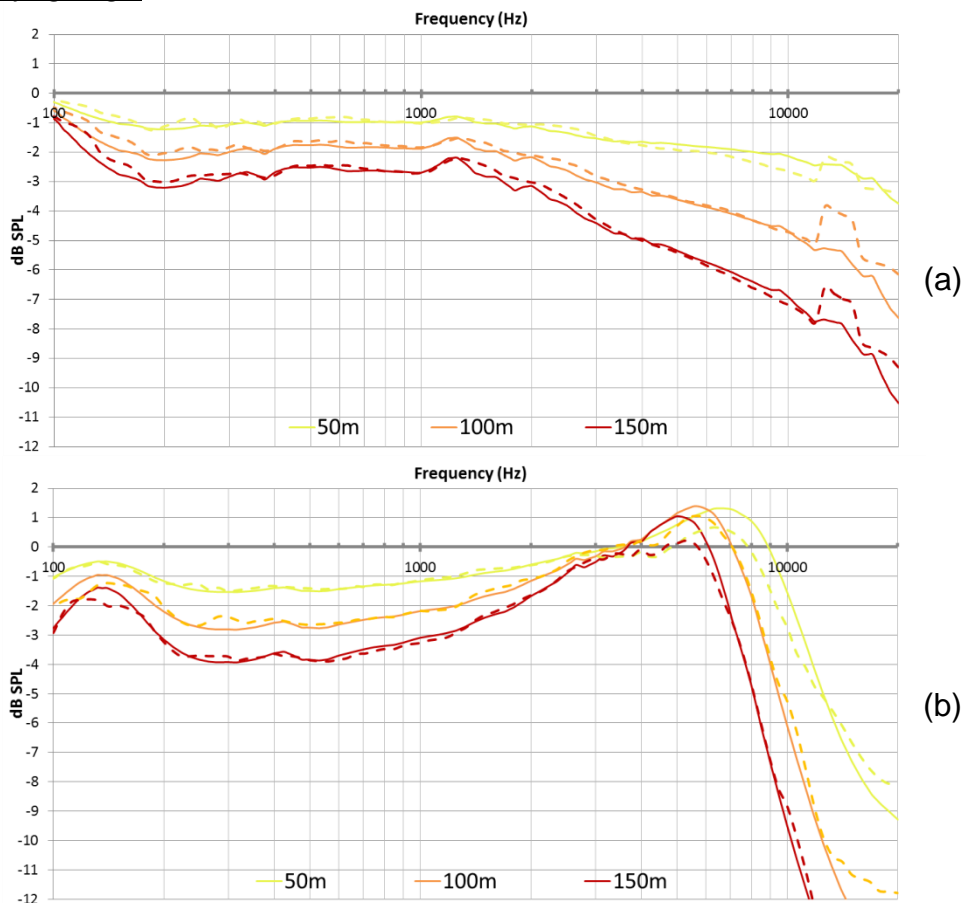

Figure 8: Simulation (solid line) vs measurement (dotted line) of power loss induced by a 4mm<sup>2</sup> cable and varying length.(a): 2 speakers A in parallel, (b): 3 speakers B in parallel

Needless to say, length is the main factor of power loss. In most cases the overall loss over the 100 Hz – 10 kHz bandwidth can be considered as proportional to the cable length.



- Varying section

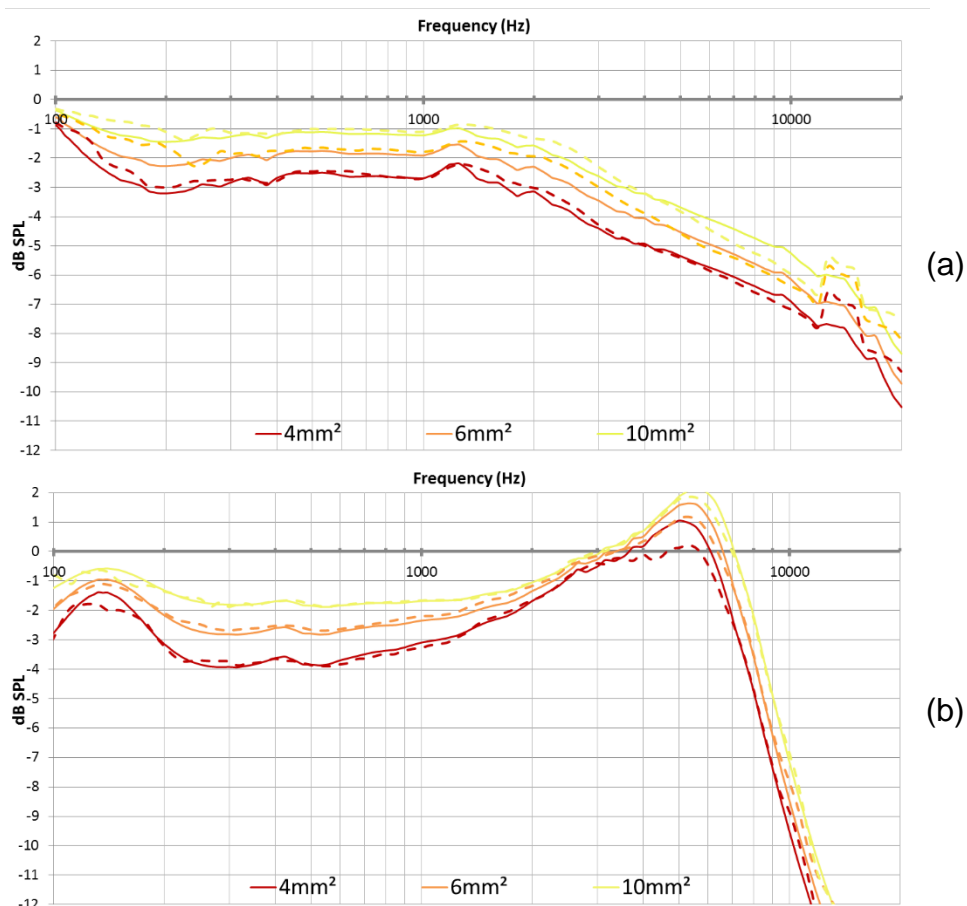

Figure 9: Simulation (solid line) vs measurement (dotted line) of power loss induced by a 150m cable and varying section. (a): 2 speakers A in parallel, (b): 3 speakers B in parallel

Section is indeed another important factor regarding power loss, but its effect is less than we could expect, especially in the high frequency. This is mainly due to the substantial skin effect present in larger cable gauge. Looking at Figure 9.a and 9.b, switching from 6mm² to 10mm² represents a gain of less than 1 dB at 10 kHz, a non-cost-efficient upgrade, considering the remaining loss is around 6 to 8 dB at this frequency.

- Varying number of enclosures in parallel

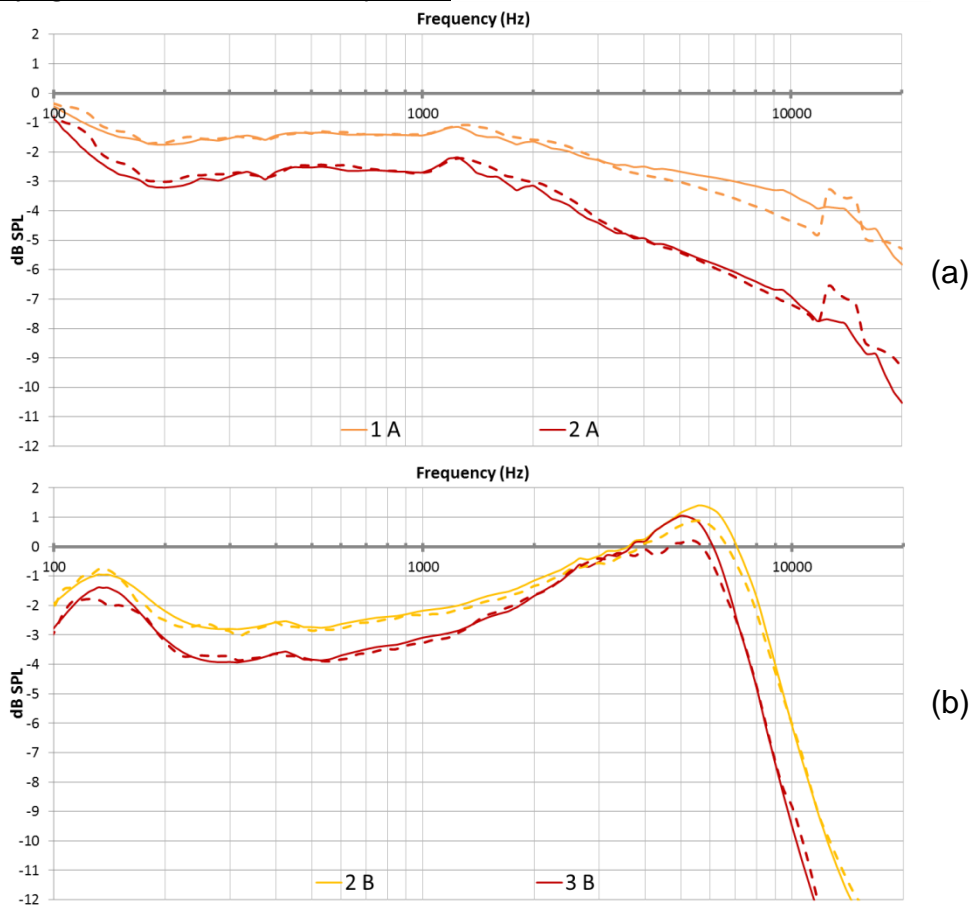

Figure 10: Simulation (solid line) vs measurement (dotted line) of power loss induced by a cable of 150m and 4mm<sup>2</sup>. (a) speakers A, (b) speakers B

The number of parallel enclosures on the same channel is also a very important factor as it directly affects the impedance load seen by the amplifier, inversely proportional to this number. In sound installations involving long cables, investing in amplification instead of big gauge cables may be wise.

#### 4.4 Observations and limitations

An important fact to note is the boost we can observe around 5 kHz on figures 8.b, 9b and 10b. Having a long cable increases the acoustic level at this particular frequency, compared to a zero-meter cable. That may seem counterintuitive at first, but there is an explanation to this; on figure 6.b we see the phase of speaker B reaching very low minima of  $-54^\circ$  at 5600 Hz, whereas at the same frequency, a long cable impedance will compensate this negative phase by a positive one, to a point where the equivalent impedance of the speaker and the cable together is lower for a long cable than for a short one, allowing for more power to be driven to the voice coil. In such conditions, this phenomenon may jeopardize the speaker integrity because the electrical headroom reduction at this given frequency is not taken into account in the amplifier limiter settings. We can also think of it the other way around, on the majority of spectrum the speaker does not deliver sound pressure to its full potential while the amplifier may have the necessary resources to reach this performance.

The model also presents some limitations. First it cannot simulate precisely the loss below 60 Hz, most probably because of the randomness of the measurements in this low-infra region and perhaps due to other unknown effects. Secondly the simulation becomes more complex in the crossover region of active speakers, because two ways implies two different impedances which can

react very differently to these electrical effects induced by the cable. This can result in a phase shift between the two voice coils which means an altered acoustic summation as well as a frequency shift of the crossover point.

## **5 CONCLUSIONS**

We have demonstrated the need to focus on power loss due to cable impedance which stands out as the major issue with regard to long loudspeaker cables, rather than the infamous damping factor. In professional sound installations, this phenomenon can have a drastic effect on frequency response as well as sound pressure level. In this research we have built an electrical model that accurately predicts the influence of cabling on a sound system. While power loss is near proportional to the length as well as the number of parallel speakers on the same channel, increasing cable section turns out to be of poor efficiency above 6mm<sup>2</sup>, mostly because of the significant skin effect in the high frequencies. SPL loss and frequency response alteration highly depends on the nature of a speaker which is defined by its unique impedance curve. L-Acoustics uses this model to develop new cabling recommendations and tools to assist sound designers to fit professional standards.

Further lines of work on this topic could take different shapes such as; a more efficient way simulate power loss below 60Hz, electrical compensation in amplifiers and an in-depth study of the phase shift induced by cables in the crossover regions of active speakers but also a more comprehensive investigation of the damping factor effects on low frequency drivers.

## **6 REFERENCES**

1. Augsperger, "The Damping Factor Debate" (1967)
2. Floyd E. Toole in "Damping, Damping Factor and Damn Nonsense" (1975)
3. Richard Clarke "Damping Factor" (2000)"
4. D.J. Tomcik "Missing Link in Speaker Operation Parts 1 & 2" (1954)
5. Johnson I. Agbinya "Principles of Inductive Near Field Communications for Internet of Things" (2011)